



Flex-Bow™ Tent  
Owner's Manual

For Model 6086



Important! For safe and proper assembly, use, and care read and follow all instructions. Everyone who uses this tent should first read this manual.

[www.KodiakCanvas.com](http://www.KodiakCanvas.com)

# **WARNING**

## **No Fire**

This tent is flammable. Keep all flame and heat sources away from the tent fabric. Never place a stove, campfire, or any other flame source in or near your tent. Never use, light, or refuel a stove, lantern, heater, or any other heat source inside your tent. Death by carbon monoxide poisoning and/or serious burns are possible.

## **Ventilation**

Maintain adequate ventilation inside your tent at all times. Death by suffocation is possible.

## **Anchor**

This tent is not free-standing. If not properly anchored it will collapse. Anchor your tent properly at all times to reduce the risk of loss or injury to the tent or occupants.

## **Campsite Choice**

Carefully consider the possibility of falling rocks or tree limbs, lightning strikes, flash floods, avalanches, strong winds, and other objective hazards when choosing a campsite to reduce the risk of loss or injury to the tent or occupants.

## **Children**

Do not leave children unattended inside a tent or camp. Do not allow children to assemble or disassemble the tent. Do not allow children to remain closed-up in a tent on hot days. Do not allow children to swing on or hang from any part of this tent, organizers, or guylines. Failure to follow these warnings may result in injury and/or death.

## **Kodiak Canvas Limited Lifetime Warranty**

This product is warranted, to the original purchaser, to be free of defects in materials and workmanship for as long as you own the product. This product is made with quality materials and expert workmanship, but is not indestructible. This warranty does not cover damage attributed to or resulting from normal wear and tear (e.g. exhausted zippers), natural hazards (e.g. weather, animals), abuse (e.g. mold, mildew, burns, ultraviolet), or alterations or modifications of any kind. If your product is found defective, we will repair or replace it free of charge. Charges for shipping your product to Kodiak Canvas will be your responsibility. We reserve the right to make substitutions if parts are unavailable or obsolete. If your product needs repair beyond what is covered under warranty, we will provide parts and service at a reasonable charge.

This warranty gives you, the original purchaser, specific legal rights. You may also have other rights which vary from state to state. **Do not return your product until you have received authorization and instruction to do so.**

To obtain service contact us at [www.KodiakCanvas.com](http://www.KodiakCanvas.com), or write to:

Kodiak Canvas Customer Service  
PO Box 762  
Layton, UT 84040 USA

# Component Checklist

- Identify all components and make sure they are in good condition and working order.

Qty	Item
1	Tent Body
1	Two-piece T-pole
1	T-pole with Sliding Brace *
4	Spring Rods
2	Upright Poles
10	12-inch Metal Stakes
1	Zippered Storage Bag
1	Pole Bag
1	Stake Bag

*\* Note that sliding brace is a steel tube that can slide off the T-pole and may be found separated from the T-pole.*

## Two-Section T-Pole

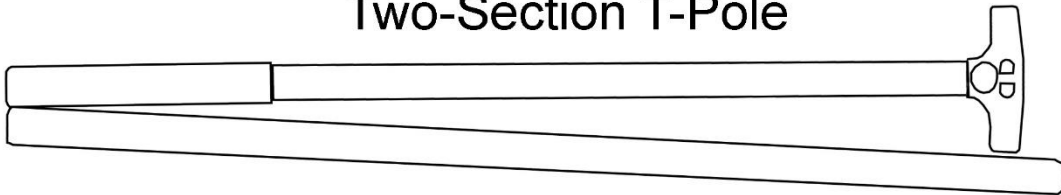

## T-Pole w/ Sliding Brace

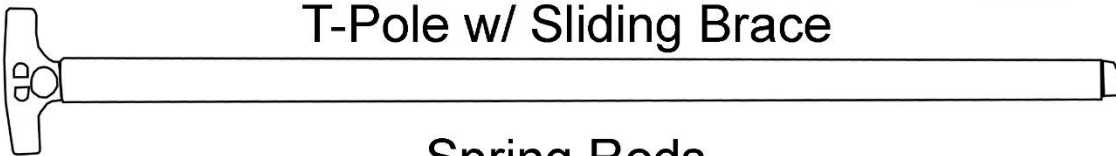

## Spring Rods

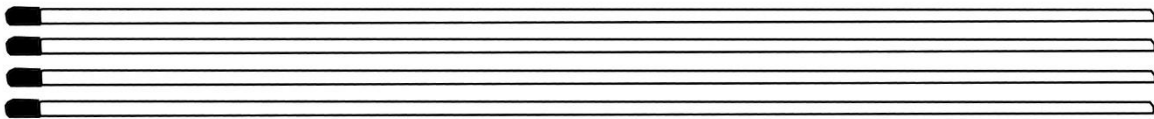

## Upright Poles

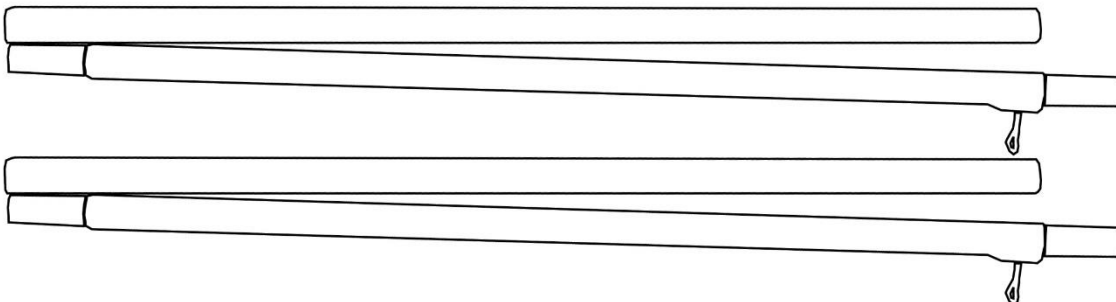

## Before You Set Out

- It is recommended that you assemble this tent at home at least once before your trip to familiarize yourself with the process, and make sure your tent is in good order.
- After initial set-up it is recommended that you spray the tent lightly with water and allow it to dry completely. This seasons the canvas. The water causes the canvas to shrink slightly, closing needle holes where the canvas was stitched. This process is only required once.

## Waterproofing

Kodiak Canvas tents are made with Hydra-Shield™ canvas that features superb water repellency. However, not all tents are completely waterproof out of the box. On occasion a new tent will experience some leaking. Over the life of the tent, occasional, waterproofing maintenance will be required. If leaking occurs, it is an easy fix. Treat the affected area with a *SILICONE* based waterproofing such as Kiwi Camp Dry®. This should absolutely take care of any leaks, and you should seldom have to retreat. Caution: Do not use other types of waterproofing such as Canvak® on this Hydra-Shield™ canvas, as it could affect the breathability of the canvas. When properly sealed, your expectation should be that a Kodiak Canvas tent will be completely dry inside, even during drenching rains.

## Assembly

**The use of protective gloves and eyewear is recommended during assembly.**

### STEP 1: Stake the Tent

Stake each of the tent's four corners, making sure that the tent is taut and square. Continue to place a stake at all the remaining stake loops (10 total) and D-rings (2). Do not over tighten. Do not yank on stake loops.

### **Tips:**

- Drive in stakes with the tip angling toward the tent. Secure hooks on the end of the stakes over the tent loops.
- In soft sand or snow, use a dead-man anchor. Bury a horizontal piece of wood approximately 12 – 18 inches deep with a guyline connecting to the stake loop. **Make sure that the anchor is secure.**

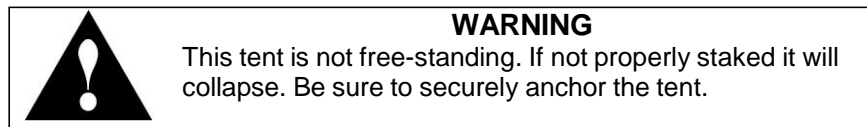

### STEP 2: Assemble the Frame

- 1) Join the two-piece T-pole.
- 2) Ensure that the sliding brace is slid all the way down onto the T-pole. It may be necessary to press the push-pin in to allow the brace to slide past. *Note that sliding brace is a steel tube that can slide off the T-pole and may be found separated from the T-pole.*
- 3) Lay both T-poles across the top of the tent. Face the posts on the T-connecters down.
- 4) Insert a spring rod through each of the four sleeves on the top of the tent and into the T-poles. The openings in the T-pole connectors allow you to see when the rods are inserted completely. **Be sure that the spring rods are inserted completely, or parts may be damaged!**

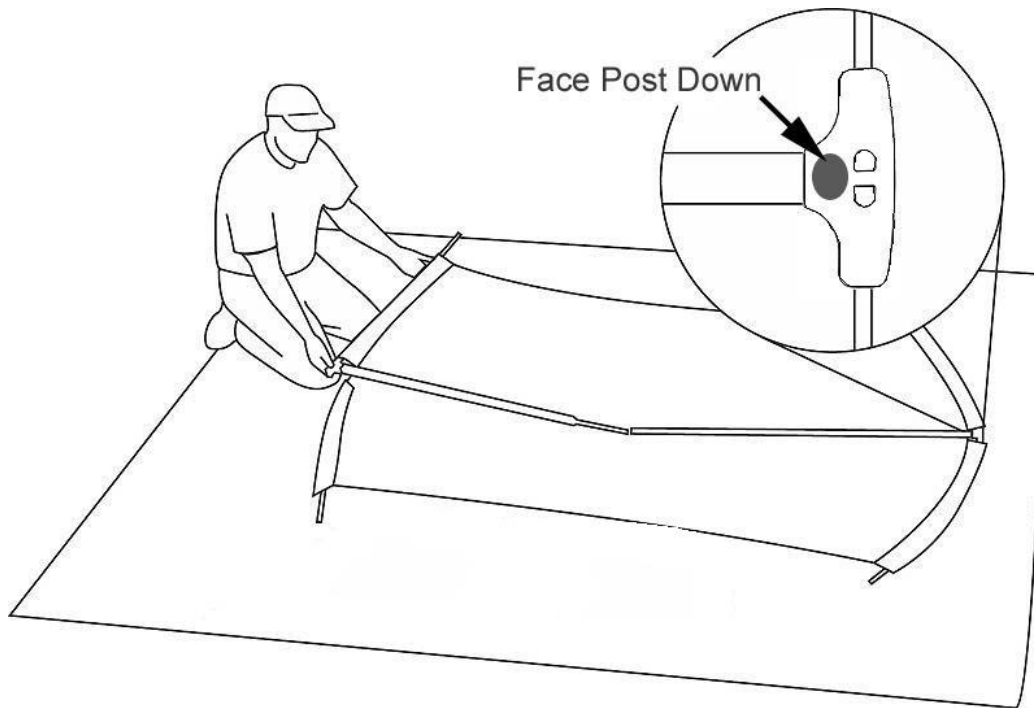

5) Match the ends of the T-poles so that they are touching. Grasp both poles firmly and push down.

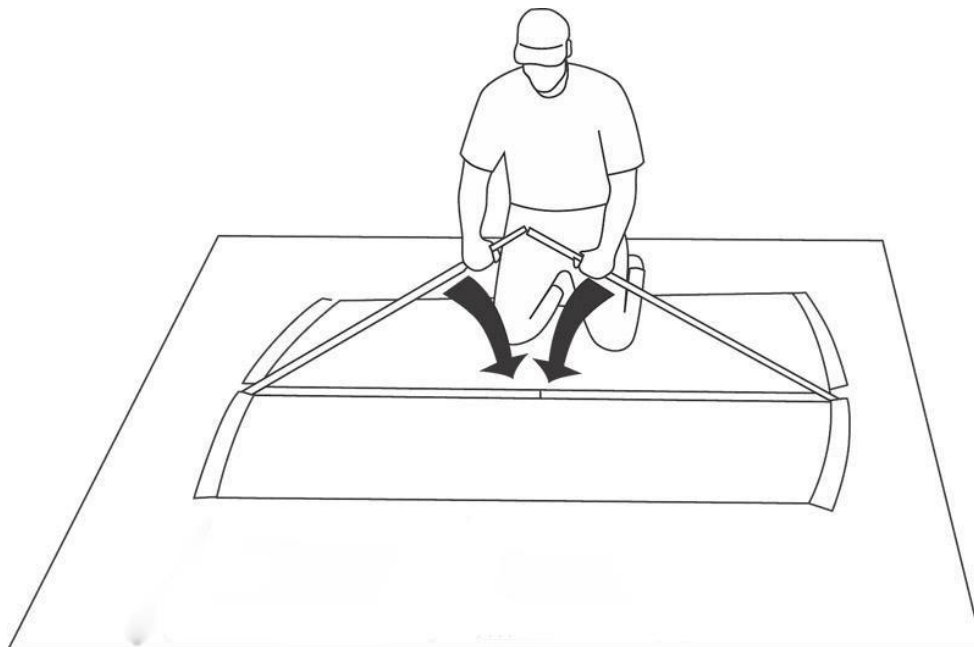

	<p><b>WARNING</b> Poles are under tension. Grasp poles firmly. Keep face away from poles. Keep hands away from the pole joint to avoid pinching.</p>
--	--

- 6) Slide the sleeve brace over the pole joint until the push-pins lock the brace into place. NOTE: To disassemble, push the pin in to slide the brace away from the joint.
- 7) Join upright poles. Pass the pole through the sleeves on the windows.



- 8) Unzip doors to allow air to enter. Raise the tent end and insert the large end of the upright pole onto the post on the bottom of the T-pole. Lift the pole and place pole bottom (smaller end) over the pin attached to the D-ring at the bottom of the tent. Lengthen the uprights by loosening the thumbscrews and extending the inner pole. Adjust the upright poles so the tent is taut—do not stretch too tight. Tighten thumbscrews finger-tight. Avoid pinch points.

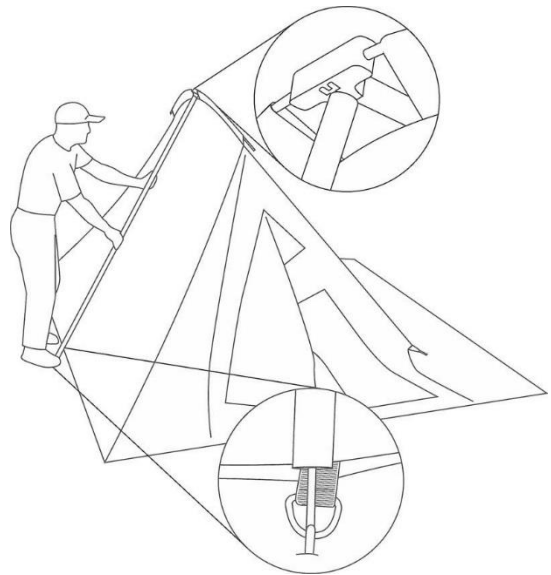

**WARNING**

Hold poles firmly. Avoid pinch points.

- 9) Repeat 6 and 7 on the other side of the tent.

## Special Features

- Interior tie-rings on the ceiling. Use them to attach gear, lights, clotheslines etc.

	<p style="text-align: center;"><b>WARNING</b></p> <p>Tie-rings are designed for lightweight gear and personal articles. Do not attach heavy objects to them or damage to the tent, or injury to the occupants may occur.</p>
---	--

- Cinch button tie-backs. Securely tie back doors, and windows.

## Taking Down and Storing the Tent

### STEP 1: Clean and Dry

- 1) Sweep out any dirt or food particles.
- 2) Empty all storage pockets.
- 3) Allow tent to dry completely! Zip down windows and allow tent to air out and dry inside and out.

	<p style="text-align: center;"><b>CAUTION</b></p> <p>VERY IMPORTANT—Your tent must be completely dry, inside and out, before storage! Your tent may be damp from condensation even if there has been no rain. Storing a wet or damp tent, even for a short time, can ruin it and void the warranty. This causes mold that will cause a bad odor, stain and deteriorate the canvas and its water repellency.</p> <p>If you must take the tent down while still wet or damp, loosely roll it for transport. After transport, immediately unroll and set up or hang out to dry thoroughly before long-term storage.</p>
---	--

### STEP 2: Collapse Tent

- 1) Unzip windows and doors.
- 2) Collapse Upright Poles. **Tip:** To loosen thumb screws, first take the weight off of the pole, then turn thumb screw.
- 3) Grasp T-pole firmly. Push in the push-pin and slide back the sleeve brace.

	<p style="text-align: center;"><b>WARNING</b></p> <p>Poles are under tension. Grasp poles firmly. Keep face away from poles.</p>
---	--

- 4) Remove all poles and stow in pole bag. **Note: A slight permanent bend in the spring rods is normal.**
- 5) Remove stakes. Clean off moisture and dirt and store in stake bag.



### CAUTION

To avoid tearing or damaging the tent, do not remove stakes by pulling with the tent stake loops. Use a hammer, a piece of rope, or a stake puller to remove stakes.

**Tip for zippered storage bags:** Fold lengthwise to the width of the storage bag and roll. Rather than lifting the rolled tent into the storage bag, place the storage bag over the rolled tent and then roll over so zipper is upright, and zip.

## Care

- **VERY IMPORTANT**—Your tent must be completely dry before storage! **STORING A WET OR DAMP TENT, EVEN FOR A SHORT TIME, CAN RUIN IT AND WILL VOID THE WARRANTY.**
- To clean tent, hose down with water and wipe with a cloth. Soaps and detergents can damage the water-repellant treatment of the canvas.
- Do not spray insecticides or bug repellent directly on the canvas. This may damage the water-repellant treatment.
- For long-term storage, store in a cool dry location that is not exposed to direct sunlight.
- This tent is equipped with quality zippers. To prolong zipper life, do not grind the zippers around corners. If needed pull the canvas, windows or doors to help zippers glide smoothly. Keep them clean from dirt.
- The canvas on your tent has a special Hydra-Shield™ treatment that is watertight yet breathable. You should rarely, if ever have to retreat the canvas. If you do need to spot treat the canvas for water repellency, use a silicone based repellent such as Camp Dry® by Kiwi®. Other treatments will clog the tiny holes in the canvas eliminating its breathability.
- Winter camping can be an enjoyable experience in a Kodiak Canvas tent. However, it is not designed for heavy snow accumulations.
- For extended use situations (more than three consecutive weeks) see Extended Use Care instructions at [www.KodiakCanvas.com](http://www.KodiakCanvas.com).

## Other Notes

- Condensation inside the tent is affected by the difference between inside and outside temperatures, and humidity. Condensation can be reduced by venting your tent. Condensation between the floor and a sleeping mat can be reduced by placing a ground cloth underneath the tent.
- Some slight irregularities are normal with 100% cotton canvas and will not affect the performance of your tent.

We appreciate your business. Thank you for purchasing a Kodiak Canvas™ tent. We put our pride into the design and manufacturing of this product. It is the best of its kind available. We wish you safe and happy camping. Please tell your friends about us.

**Find info, accessories, replacement parts and**

**other products at: [www.KodiakCanvas.com](http://www.KodiakCanvas.com)**